



光继电器

Photo Relay

QXS258A

宁波群芯微电子股份有限公司

NINGBO QUNXIN MICROELECTRONICS CO., LTD.

中国 浙江省宁波杭州湾新区玉海东路 68 号

68 Yuhaidong Road, Hangzhou Bay New District, Ningbo, Zhejiang, China

概述 Description

QXS258A是一款高压继电器，通过高压输出检测器电路光耦合到AlGaAs红外发光二极管（LED）输入级。高压输出检测器电路由一个高速光伏二极管阵列和驱动电路组成，用于接通/断开两个分立的高压MOSFETs。

QXS258A可以提供更强的绝缘和可靠性，在高温工业应用中提供安全的信号隔离。16引脚封装（SOP16）。

The QXS258A series is a high-voltage Photo MOSFET. It is optically coupled to the AlGaAs infrared light-emitting diode (LED) input stage optically coupled to a high-voltage output detector circuit. The high voltage output detector circuit consists of a high-speed photovoltaic diode array and driver circuitry to switch on/off two discrete high-voltage MOSFETs.

The QXS258A series provides reinforced insulation and reliability that delivers safe signal isolation critical in high temperature industrial applications. It is packaged in a 16-pin package.

特性 Features

- 紧凑型固态双向信号开关
Compact solid-state bidirectional signal switch
- 输入-输出隔离电压 ($V_{ISO}=5000 V_{rms}$)
High isolation voltage between input and output ($V_{ISO}=5000 V_{rms}$)
- 工作温度: $-40^{\circ}C \sim +125^{\circ}C$
Operating Temperature: $-40^{\circ}C \sim +125^{\circ}C$
- 低关断漏电流
Low off state leakage current
- 符合加强绝缘标准
Meet reinforced insulation standards
- 无铅, 符合 RoHS 标准
Pb free and RoHS compliant
- 符合 AEC-Q101 车规标准
Meet AEC-Q101 vehicle regulation level standard
- 安全和监管批准
Safety and regulatory approvals
—CQC 认证: GB 4943.1-2022 (编号: CQC22001352993)
CQC approved: GB 4943.1-2022 (NO: CQC22001352993)
—UL 认证: UL1577(编号: UL-US-2236520-0)
UL approved: UL1577 (NO: UL-US-2236520-0)
—VDE 认证: DIN EN IEC 60747-5-5 (VDE 0884-5):2021-10; EN IEC 60747-5-5:2020 (编号: 40051490)
VDE approved: DIN EN IEC 60747-5-5 (VDE 0884-5):2021-10; EN IEC 60747-5-5:2020 (NO: 40051490)

应用 Applications

- 蓄电池绝缘电阻测量/漏电检测
Battery insulation resistance measurement/leakage detection
- 汽车电池 BMS 拓扑结构
Automotive battery BMS topological structure

封装和原理图 Package and Schematic Diagram

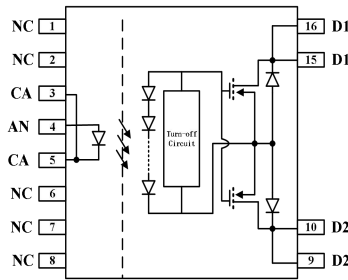
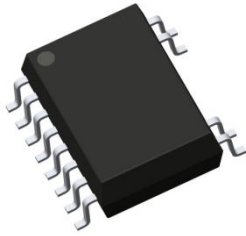

Pin Configuration

- 1, 2, 6, 7, 8. No connection
- 3. Do not connect (internally connected to Pin 5)
- 4. Anode
- 5. Cathode
- 9, 10. Drain 2 (internally connected)
- 15, 16. Drain 1 (internally connected)

产品型号命名规则 Order Code

QX S258A - UN Y - W (V) (ZZ)

- ① ② ③ ④ ⑤ ⑥ ⑦

- ① 公司代码 Company Code (QX: 群芯 Qunxin)
- ② 产品系列 Product Series (S258A: S258A)
- ③ 框架类型 Lead Frame (Cu: 铜框架 Copper)
- ④ 树脂类型 Epoxy Type (H: 无卤 Halogen-free)
- ⑤ 封装形式 Package (S: SOP)
- ⑥ 器件工作温度范围 Device Operating Temperature Range (特殊范围需填或者空白 Special Range need to be filled in or left blank)
- ⑦ 内部补充代码 Internal Supplementary Code (数字或者空白 Number or None)

印字信息 Marking Information

- 印字中“”为群芯品牌 LOGO
“”denotes LOGO
- 印字中“Y”代表年份: A(2018), B(2019), C(2020).....
“Y”denotes YEAR: A(2018), B(2019), C(2020).....
- 印字中“WW”代表周号
“WW”denotes Week’s number.
- 印字中“N”代表星期几
“N”denotes the day of the week.
- 印字中的“H”代表无卤
“H”denotes Halogen-free
- 印字中的“T”代表车规产品
“T”denotes the Vehicle specification products.



绝缘和安规信息 Insulation and Safety related specifications

项目 Item	符号 Symbol	数值 Value	单位 Unit	备注 Note
爬电距离 Creepage Distance	L	8.3	mm	从输入端到输出端，沿本体最短距离路径 Measured from input terminals to output terminals, shortest distance path along body.
电气间隙 Clearance Distance	L	8.3	mm	从输入端到输出端，通过空气的最短距离 Measured from input terminals to output terminals, shortest distance through air.
绝缘距离 Insulation Thickness	DTI	0.5	mm	发射器和探测器之间的绝缘厚度 Insulation thickness between emitter and detector.
峰值隔离电压 Peak Isolation Voltage	V_{IORM}	1500	V_{peak}	DIN/EN/IEC EN60747-5-5.
瞬态隔离电压 Transient Isolation Voltage	V_{IOTM}	8000	V_{peak}	DIN/EN/IEC EN60747-5-5.
隔离电压 Isolation Voltage	V_{ISO}	5000	V_{rms}	RH ≤ 50%, $t_m = 1$ minute, $T_A = 25^\circ C$.

极限参数 Absolute Maximum Ratings ($T_A=25^\circ C$)

参数 Parameter		符号 Symbol	额定值 Rating	单位 Unit	备注 Note
发射端 Input	LED 正向电流 LED Forward Current	I_F	50	mA	$T_A = -40^\circ C$ to $+125^\circ C$
	LED 反向电压 LED Reverse Voltage	V_R	5	V	$T_A = -40^\circ C$ to $+125^\circ C$
	峰值正向电流 Peak Forward Current	I_{FP}	1	A	f = 100 Hz, duty cycle = 0.1%
接收端 Output	持续负载电流 Continuous Load Current	I_L $T_A = 25^\circ C$	0.02	A	100 ms (1 pulse) $V_L = DC$
		I_L $T_A = 125^\circ C$	0.02	A	
	峰值负载电流 Peak Load Current	I_{peak} $T_A = 25^\circ C$	0.06	A	
		I_{peak} $T_A = 125^\circ C$	0.06	A	
	雪崩电流 avalanche current	I_{AV}	0.6	mA	
输出功率 Power Dissipation	P_{out}	900	mW		
总功耗 Total Power Dissipation		P_{tot}	1000	mW	
输入输出瞬态耐受电压 Isolation Voltage		V_{ISO}	5000	V_{rms}	RH ≤ 50% $t_m = 1$ minute
工作温度 Operating Temperature		T_{opr}	-40~+125	$^\circ C$	
存储温度 Storage Temperature		T_{stg}	-55~+150	$^\circ C$	

参数 Parameter	符号 Symbol	额定值 Rating	单位 Unit	备注 Note
焊接温度 Soldering Temperature	T_{sol}	260	°C	

推荐的操作条件 Recommended Operating Conditions

参数 Parameter	符号 Symbol	最小 Min.	最大 Max.	单位 Unit	备注 Note
电源电压 Supply Voltage	V_{DD}	-	1000	V	
输入电流 (ON) Input Current (ON)	$I_{F(ON)}$	5	10	mA	
输入电压 (OFF) Input Voltage (OFF)	$V_{F(OFF)}$	-5	0.4	V	
工作温度 Operating Temperature	T_A	-40	+125	°C	
持续负载电压 Continuous Load Voltage	V_O	-	1000	V_{DC}	
负载电流 Load Current	I_O	-10	10	mA	

产品特性参数 Electro-optical Characteristics (T_A=25°C)

参数 Parameter		符号 Symbol	条件 Condition	最小 Min.	典型 Typ.	最大 Max.	单位 Unit
发射端 Input	LED 开启电流 LED Operate Current	I _{Fon}	I _L = Max.	-	1.73	3	mA
	LED 关断电流 LED Turn Off Current	I _{Foff}	I _L = Max	0.2	1.57	-	mA
	反向电流 Reverse Current	I _R	V _R = 5V	-	-	10	uA
	LED 正向压降 LED Dropout Voltage	V _F	I _F =5mA	-	1.35	1.5	V
接收端 Output	负载电压 (AC 峰值) Load Voltage (Peak AC)	V _L	I _{OFF} =10uA	1500	-	-	V
	导通电阻 On Resistance	R _{on} T _A = 25°C	I _F = 5mA I _L = Max. Within 1s on time	-	39	150	Ω
		R _{on} T _A = 125°C	I _F = 5mA I _L = Max. Within 1s on time	-	40	150	Ω
	关断漏电 Off State Leakage Current	I _{Leak}	I _F = 0mA; V _L = 1500V	-	0.25	10	uA
输出电容 Output Capacitance	C _{OUT}	V _B = 0V, f = 1MHz	-	60	-	pF	
传输特性 Transfer Characteristics	开启时间 Turn On Time	T _{on}	I _F = 5mA; I _L = 20mA T _A =25 °C	-	346	1500	us
			I _F = 5mA; I _L = 20mA T _A =-40 to +125 °C	-	-	1500	us
	关断时间 Turn Off Time	T _{off}	I _F = 5mA; I _L = 20mA T _A =25 °C	-	151	500	us
			I _F = 5mA; I _L = 20mA T _A =-40 to +125 °C	-	-	500	us
	I/O 电容 I/O Capacitance	C _{ISO}	f = 1MHz; V _B =0V	-	1.3	3	pF
	初始 I/O 隔离电阻 Initial I/O Isolation Resistance	R _{ISO}	500 V DC	10 ⁹	-	-	Ω

典型光电特性曲线 Typical Electro-Optical Characteristics Curves

Fig.1 On Resistance vs. Ambient Temperature Characteristics (DC)

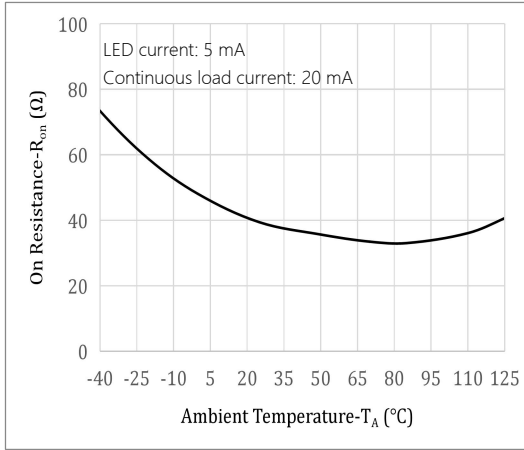

Fig.2 Load Current vs. Output Voltage Characteristics

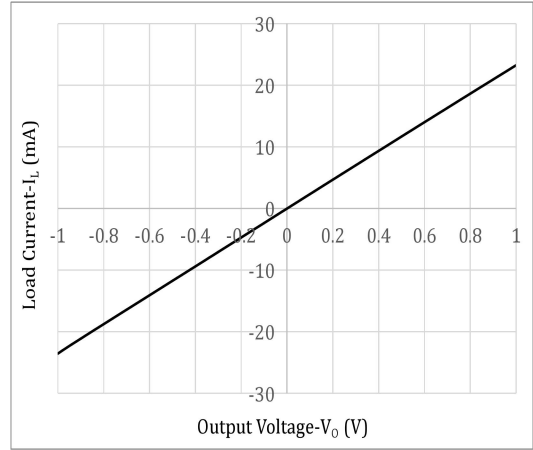

Fig.3 LED Operate Current vs. Ambient Temperature Characteristics

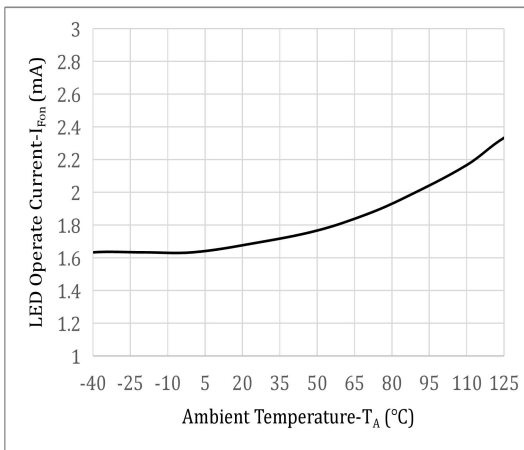

Fig.4 LED Turn Off Current vs. Ambient Temperature Characteristics

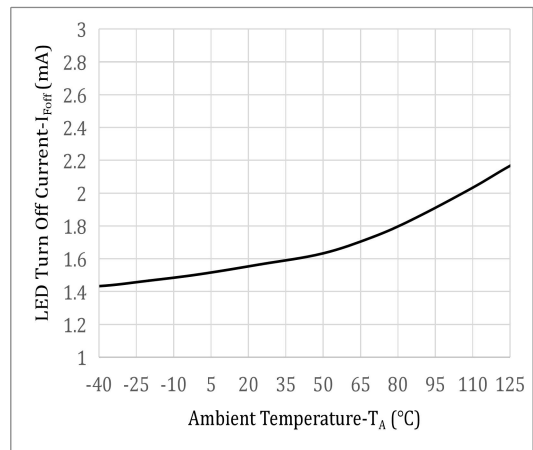

Fig.5 Turn On Time vs. Ambient Temperature Characteristics

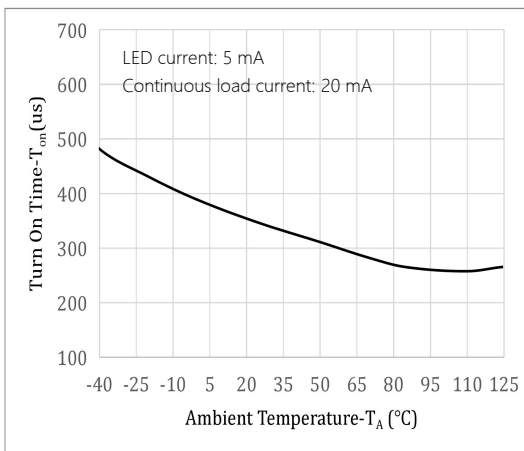

Fig.6 Turn Off Time vs. Ambient Temperature Characteristics

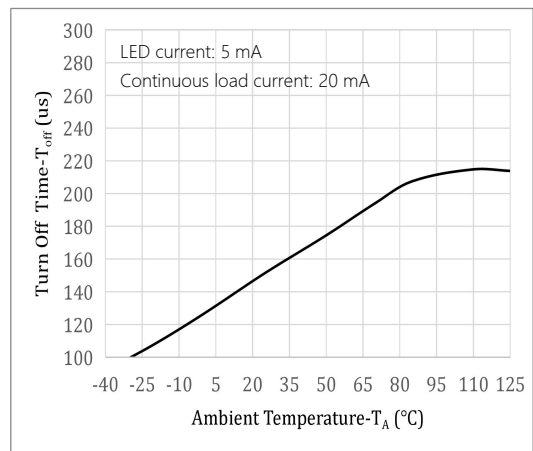

Fig.7 Turn On Time vs. LED Forward Current Characteristics

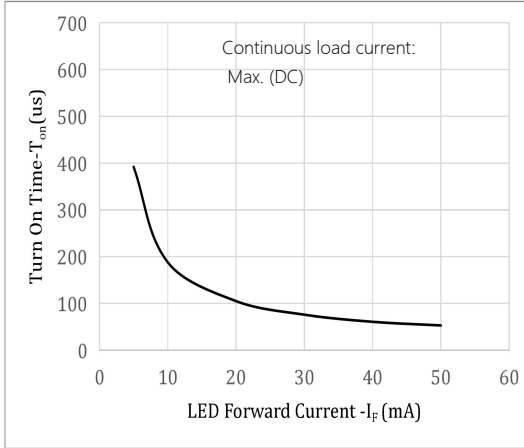

Fig.9 LED Forward Current vs LED Forward Voltage

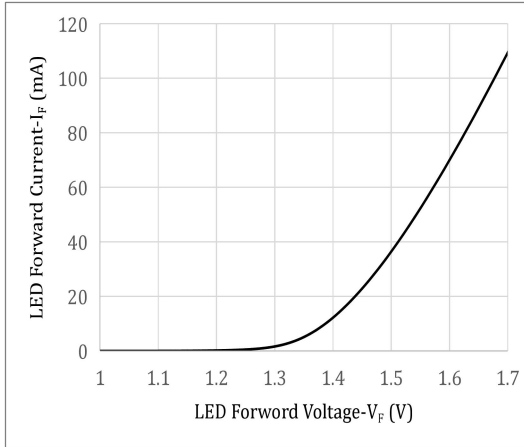
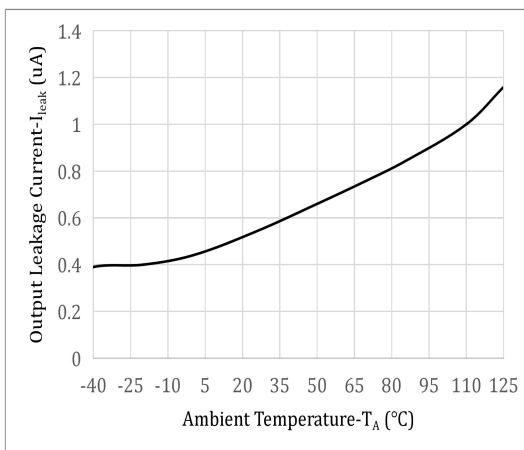

Fig.11 Output Leakage Current vs Ambient Temperature



注：光电特性曲线测试样品容量为 5 颗。

Note: The test sample capacity of the typical performance curves is 5pcs.

Fig.8 Turn Off Time vs. LED Forward Current Characteristics

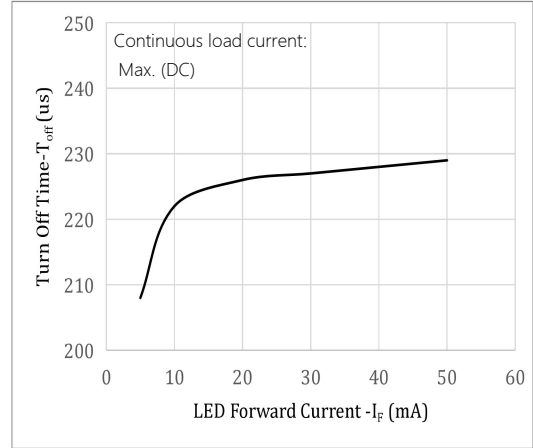

Fig.10 LED Dropout Voltage vs. Ambient Temperature Characteristics

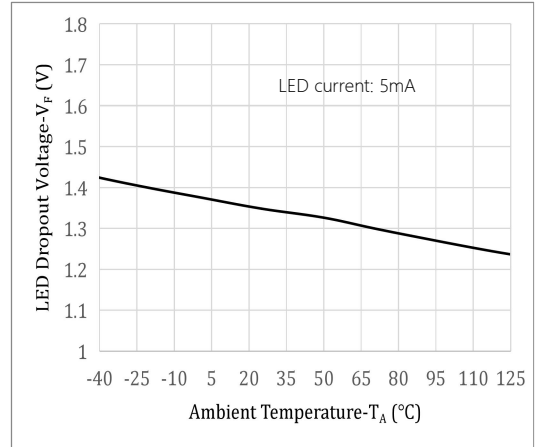
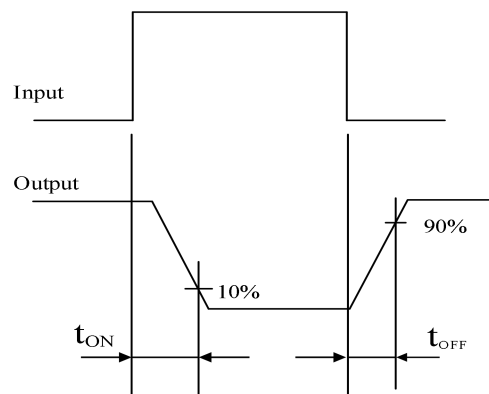

Fig.12 Turn On/Off Time



应用信息 Application Information

QXS258A 是一种单通道，无输出功率要求的光 MOSFET，其功能类似一个双向开关。LED 通过限流电阻驱动输入端（图 13）。建议输入正向电流为 5mA 至 10mA。

QXS258A is a single-channel Photo MOSFET with no output power requirement, which likes a bidirectional switch. The input side is LED driven and requires a current limiting resistor (Figure 13). Recommended input forward current is 5mA to 10mA.

输入端 LED 通过光电二极管堆叠进行光学耦合，通过驱动电路来驱动两个高压 MOSFETs。当电流被驱动到 LED 时，光在光电二极管上产生光电流，为 MOSFETs 的栅极充电，以保证器件的导通。

The input LED is optically coupled by a stack of photodiodes, which drive the two high-voltage MOSFETs through a drive circuit. When the current is driven to the LED, the light creates photo current on the photodiode to charge the gate of the MOSFETs, to switch and keep the device on.

一种典型的应用电路（如图 13），QXS258A 的输入由微处理器控制，输出端（高压侧）导通。QXS258A 的电隔离可避免电路的低压侧（输入）受到高压侧（输出）的影响。

A typical application circuit (Figure 13) shows QXS258A's input being controlled by the microprocessor to switch the output (high voltage side). The galvanic isolation of QXS258A protects the low voltage side of the circuit (input) from the high-voltage side (output).

引脚 8 至 9 和 15 至 16 在内部连接。在进行 PCB 布局时，可以使用两个脚中的任何一个引脚。也可以将引脚（8 至 9）和（15 至 16）短路。

Pins 8 to 9 and 15 to 16 are internally connected. In routing the PCB layout, either of the pins can be used. Shorting the pins (8 to 9) and (15 to 16) is also acceptable.

Fig.13 Typical Application Circuit

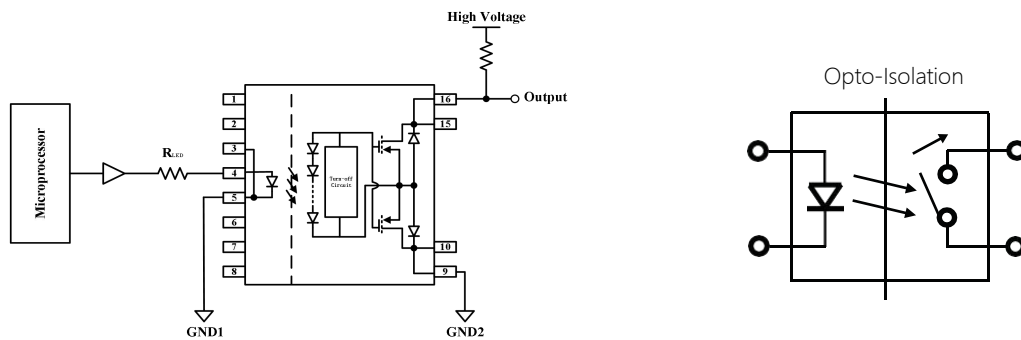

启动时间 Turn On Time

T_{ON} 受输入电流的影响。随着输入电流的增加， T_{ON} 变短。在 LED 允许的最大工作电流范围内，通过增加输入电流可实现 T_{ON} 加速，如图 14 所示。

T_{ON} is influenced by the level of input current. As input current is increased, the T_{ON} becomes shorter. In a situation where T_{ON} needs to be shorter than what the maximum level of input current can achieve, peaking can be implemented as shown in Figure 14.

Fig.14 Peaking Circuit and Sample Input Timing

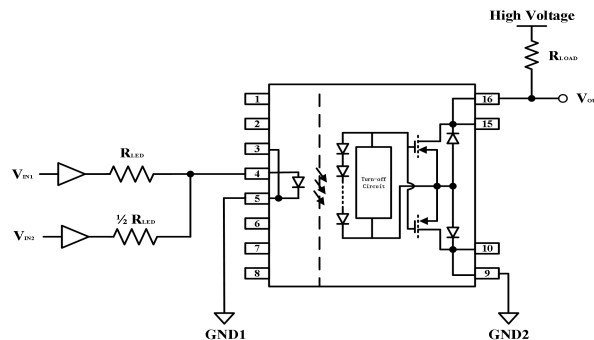

注：在此电路中，LED 可以由两个输入端驱动，以实现更小的 T_{ON} 。第二个输入 V_{IN2} 的占空比必须设置为较低的占空比，才能达到最佳效果。

Note: In this circuit, the LED can be driven by two inputs to achieve shorter T_{ON} . The second input V_{IN2} 's duty cycle must set to a lower duty cycle to achieve the peaking effect.

外形尺寸 Outline Dimensions

SOP16

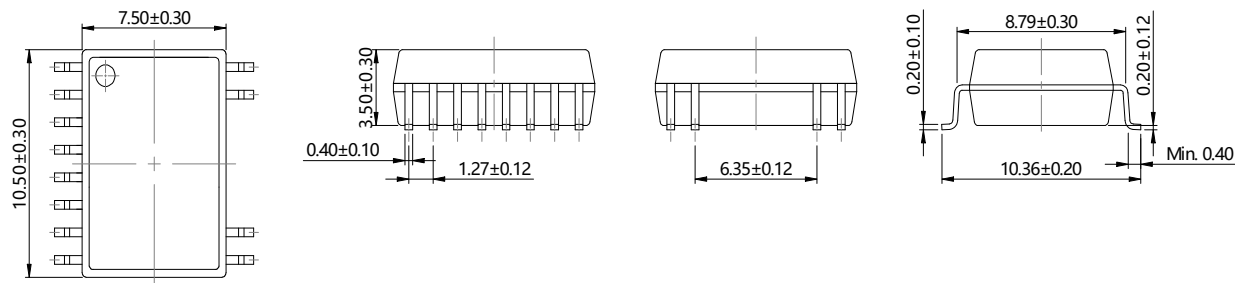

单位 Unit: mm

建议焊盘布局 Recommended Pad Layout

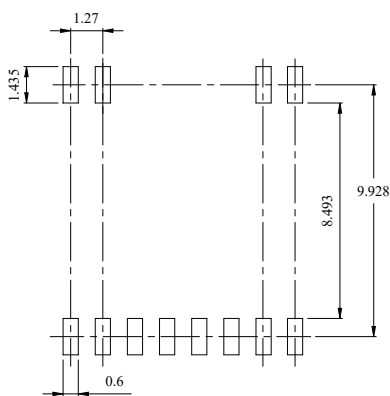

单位 Unit: mm

注：上图为产品正视图。

Note: The picture above is the front view of the product.

回流焊温度曲线图 Solder Reflow Profile

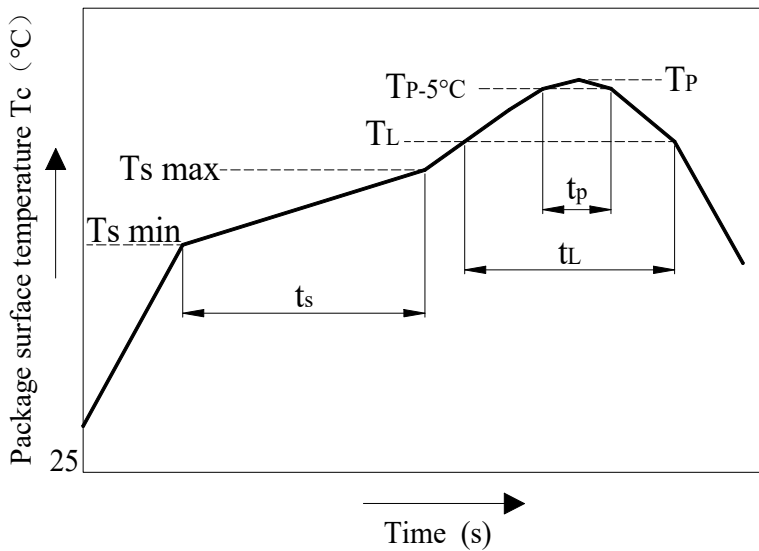

项目 Item	符号 Symbol	最小值 Min.	最大值 Max.	单位 Unit
预热温度 Preheat Temperature	T_s	150	200	$^\circ\text{C}$
预热时间 Preheat Time	t_s	60	120	s
升温速率 Ramp-Up Rate (T_L to T_P)	-	-	3	$^\circ\text{C/s}$
液相线温度 Liquidus Temperature	T_L	217		$^\circ\text{C}$
时间高于 T_L Time Above T_L	t_L	60	150	s
峰值温度 Peak Temperature	T_P	-	260	$^\circ\text{C}$
T_C 在 $(T_P - 5)$ 和 T_P 之间的时间 Time During Which T_C Is Between $(T_P - 5)$ and T_P	t_p	-	30	s
降温速率 Ramp-down Rate (T_P to T_L)	-	-	6	$^\circ\text{C/s}$

注：建议在所示的温度和时间条件下进行回流焊，最多不能超过三次。

Note: Reflow soldering is recommended at the temperatures and times shown, no more than three times.

波峰焊温度曲线图 Wave Soldering Profile

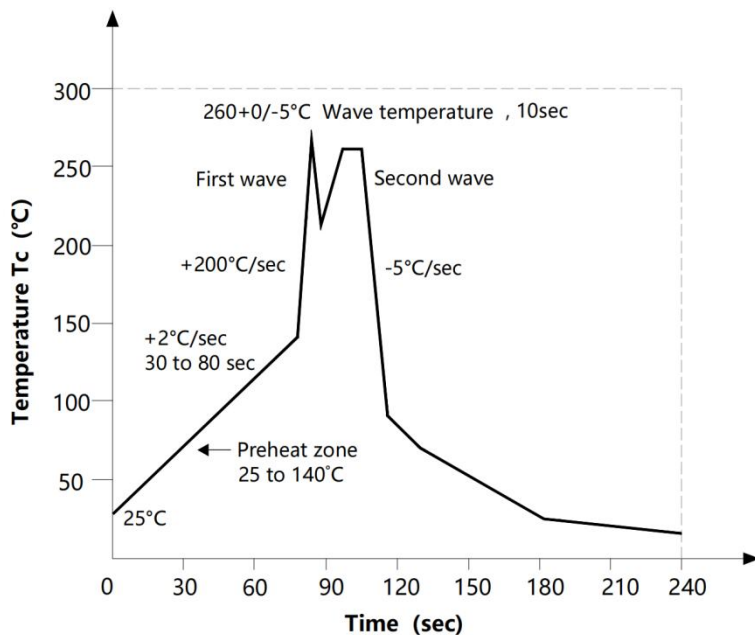

手工烙铁焊接 Soldering with hand soldering iron

- A. 手工烙铁焊仅用于产品返修或样品测试;
Hand soldering iron is only used for product rework or sample testing;
- B. 手工烙铁焊要求: 温度 $360^{\circ}\text{C} \pm 5^{\circ}\text{C}$, 时间 $\leq 3\text{s}$.
Manual soldering method Temperature: $360^{\circ}\text{C} \pm 5^{\circ}\text{C}$, within 3s.

包装 Packing

■ 汇总表 Summary table

封装形式	包装方式	盘数量	盒数量	箱数量	静电袋规格	盒规格	箱(双瓦楞)规格	备注
Package Type	Packing Form	Quantity per Reel	Quantity per Box	Quantity per Carton	Antistatic Bag Specification	Box Specification	Carton Specification	Note
SOP16	卷盘 (φ330mm 蓝盘)	850 只/盘	2 盘/盒	8 盒/箱	450*390*0.1mm	340*340*75mm	650*375*365mm	首端空 50 个空格, 末端空 100 个空格
SOP16	Reel (φ330mm Blue)	850 pcs/reel	2 reels/box	8 boxes/ctn	450*390*0.1mm	340*340*75mm	650*375*365mm	Leave 50 Spaces at the beginning and 100 Spaces at the end

■ 编带包装 Tape & Reel

- 1) 每卷数量: 850 只。
Qty/reel: 850 pcs.
- 2) 每箱数量: 13600 只。
Qty/ctn: 13600 pcs.
- 3) 内包装: 每盒 2 盘。
Inner packing: 2 reels/box.
- 4) 示意图 Schematic:

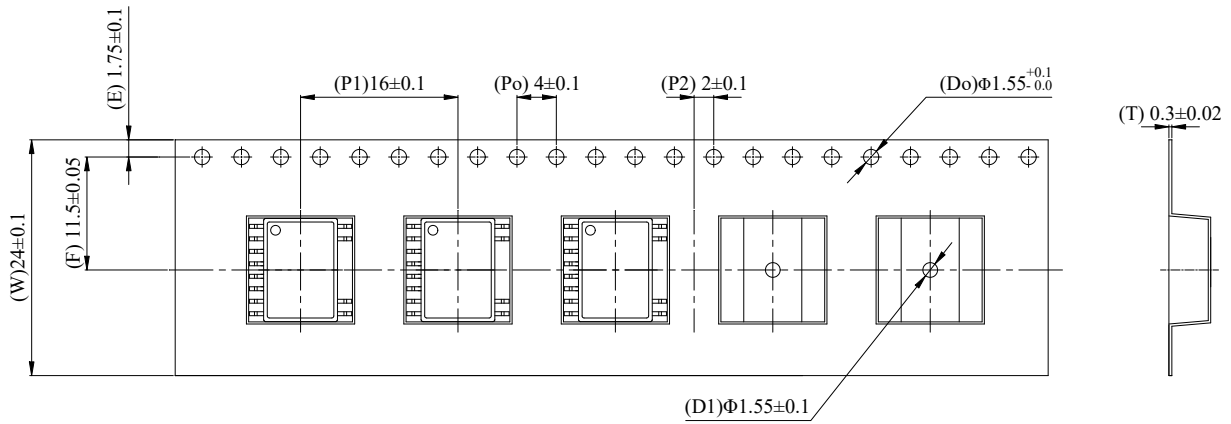

单位 Unit: mm

注意 Attention

- 群芯持续不断改进质量、可靠性、功能或设计，保留此文件更改的权利恕不另行通知。
QUNXIN continuously improve quality, reliability, function or design. We reserve the right to change this document without notice.
- 请遵守产品规格书使用，群芯不对使用时不符合产品规格书条件而导致的质量问题负责。
Please use in accordance with the product specification. QUNXIN is not responsible for the quality problems caused by non-compliance with the product specifications.
- 对于需要高可靠性或安全性的设备/装置需求，请联系我们的销售人员。
For equipment/devices where high reliability or safety is required, please contact our sales representatives.
- 当需要用于任何“特定”应用时，请咨询我们的销售人员。
When requiring a device for any “specific” application, please contact our sales in advice.
- 如对文件中表述的内容有疑问，欢迎联系我们。
If you have any questions about the contents of the document, please contact us.